

RECEPTACLE

PLUG

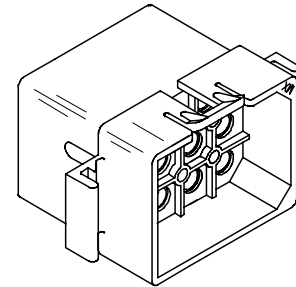
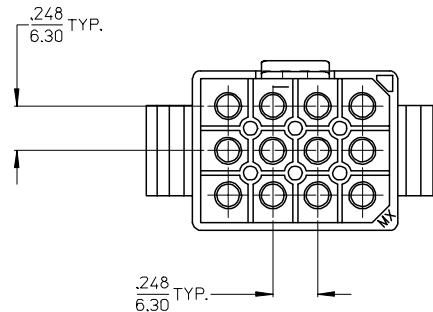
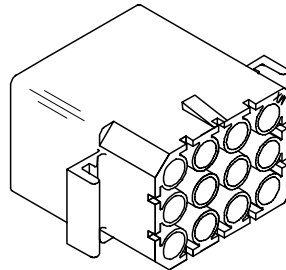
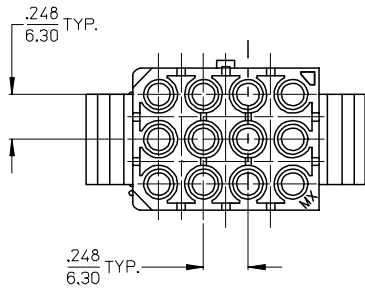
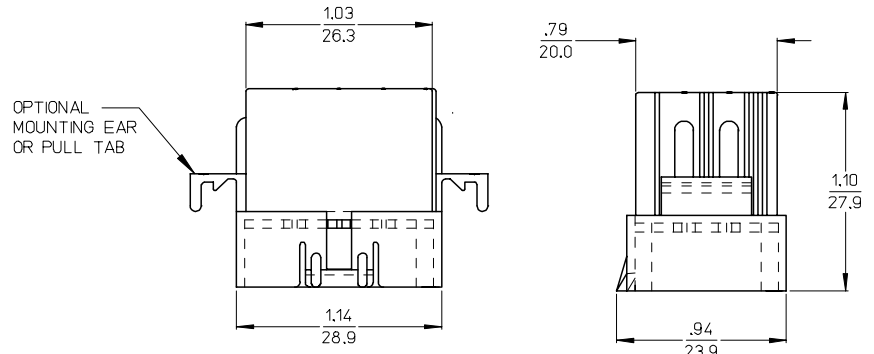
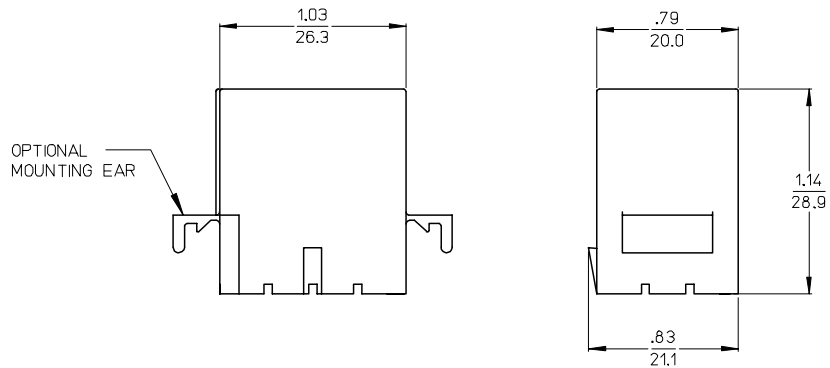
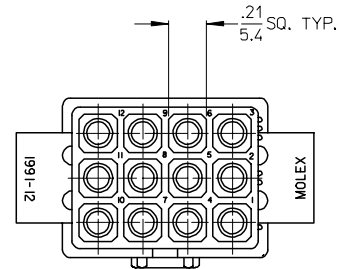
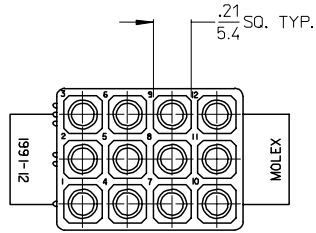

2	E
1	E
SHT., REV.	

UPDATE TITLE BLOCK FC NO: UCP2007-1498 DRWNA: AELHAG CHKD: AELHAG APPR: FSM TH 2007/04/04 2007/04/04 2007/04/04	QUALITY SYMBOLS ▽=0 ▽=0	GENERAL TOLERANCES (UNLESS SPECIFIED)		DIMENSION STYLE IN/MM		SCALE 2:1	DESIGN UNITS INCH	THIRD ANGLE PROJECTION	
		4 PLACES ± --- ± ---	3 PLACES ± --- ± .010	DRAWN BY KBW	DATE 1989/04/25	TITLE .093/(2.36) HOUSINGS PLUG & RECEPTACLE 12 CKT .248/(6.30) CENTERS			
		2 PLACES ± 0.25 ± .014	1 PLACE ± 0.35 ± ---	CHECKED BY RW	DATE 1989/04/25	APPROVED BY RAS			
		ANGULAR ±1/2°		MATERIAL NO. SEE CHART		DOCUMENT NO. SD-1991-12*		SHEET NO. 1 OF 2	
DRAFT WHERE APPLICABLE MUST REMAIN WITHIN DIMENSIONS				SIZE C		THIS DRAWING CONTAINS INFORMATION THAT IS PROPRIETARY TO MOLEX INCORPORATED AND SHOULD NOT BE USED WITHOUT WRITTEN PERMISSION			

13 12 11 10 9 8 7 6 5 4 3 2 1

PLUG		
ORDER NO	ENG NO	PKG. INFORMATION
I9 -09-2 I21	I991-12P	PK-1991-001
I9 -09-2 I22	I991-12P2	PK-1991-002
I9 -09-7 I21	I991-12PBK	PK-1991-001
-	-	-
-	-	-

RECEPTACLE		
ORDER NO	ENG NO	PKG. INFORMATION
I9 -09-1 I21	I991-12R2	PK-1991-001
I9 -09-1 I22	I991-12R1	PK-1991-002
I9 -09-6 I21	I991-12R2BK	PK-1991-001
I9 -09-6 I22	I991-12R1BK	PK-1991-001
-	-	-
-	-	-

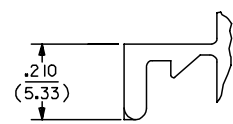

DETAIL A
STANDARD MOUNTING EAR
(SCALE 4:1)

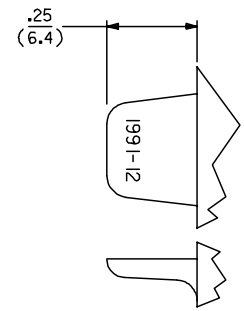
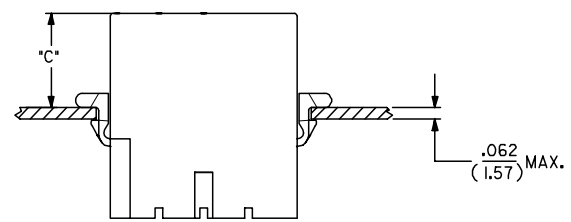
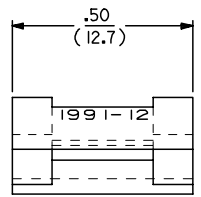

DETAIL C
PULL TAB
(SCALE 4:1)

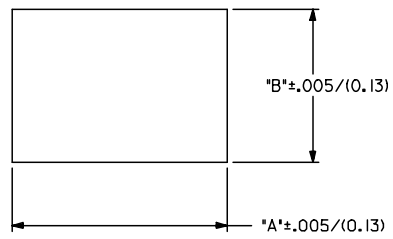

RECOMMENDED PANEL OPENING

HOUSING	DIM. "A"	DIM. "B"	"C" PREBENT EAR	"C" STANDARD EAR
PLUG	1.300/(33.02)	.910/(23.11)	.31/(7.9)	.30/(7.6)
RECEPT.	1.194/(30.33)	.850/(21.60)	.54/(13.7)	.53/(13.5)

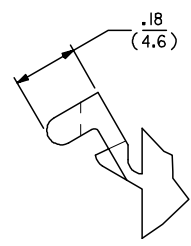

DETAIL B
PREBENT MOUNTING EAR
(SCALE 4:1)

LEGEND:

I991-12****

CIRCUIT SIZE →

P = PLUG
R = RECEPTACLE

BLANK = WITH PULL TABS
1 = WITHOUT EARS/WITHOUT PULL TABS
2 = WITH STANDARD EARS
3 = WITH PREBENT EARS

COLOR: _____

BLANK = NATURAL COLOR
AM = AMBER BK = BLACK BU = BLUE
BN = BROWN GY = GRAY GN = GREEN
OR = ORANGE RD = RED YW = YELLOW

- NOTES:**
1. MATERIAL: NYLON TYPE 6/6, 94V-2 PER E.S.-128A-x.
 2. FINISH: N/A
 3. PRODUCT SPECIFICATION: PS-02-09
 4. PACKAGING INFORMATION: SEE CHART
 5. HOUSINGS FOR USE WITH MOLEX STANDARD .093/(2.36) TYPE TERMINALS.
 6. PARTS CONFORM TO CLASS B REQUIREMENTS OF COSMETIC SPECIFICATION PS-45499-002.

ADD NOTES 2,4 & 6 EC NO: UCP2007-1498 DRWNAELHAG 2007/04/04 CHKD: AELHAG 2007/04/04 APPR: FSM TH 2007/04/04 REVISIONS	QUALITY SYMBOLS ▽=0 ▽=0	GENERAL TOLERANCES (UNLESS SPECIFIED) <table border="1"> <tr> <th></th> <th>mm</th> <th>INCH</th> </tr> <tr> <td>4 PLACES ± ---</td> <td>± ---</td> <td>± ---</td> </tr> <tr> <td>3 PLACES ± ---</td> <td>± .010</td> <td>± .010</td> </tr> <tr> <td>2 PLACES ± 0.25</td> <td>± .014</td> <td>± .014</td> </tr> <tr> <td>1 PLACE ± 0.35</td> <td>± ---</td> <td>± ---</td> </tr> </table>		mm	INCH	4 PLACES ± ---	± ---	± ---	3 PLACES ± ---	± .010	± .010	2 PLACES ± 0.25	± .014	± .014	1 PLACE ± 0.35	± ---	± ---	DIMENSION STYLE IN/MM	SCALE 2:1 DESIGN UNITS INCH THIRD ANGLE PROJECTION
		mm	INCH																
	4 PLACES ± ---	± ---	± ---																
	3 PLACES ± ---	± .010	± .010																
2 PLACES ± 0.25	± .014	± .014																	
1 PLACE ± 0.35	± ---	± ---																	
		DRAWN BY KBW DATE 1989/04/25 CHECKED BY RW DATE 1989/04/25 APPROVED BY RAS DATE 1989/04/25	TITLE .093/(2.36) HOUSINGS PLUG & RECEPTACLE 12 CKT .248/(6.30) CENTERS																
		MATERIAL NO. SEE CHART	MOLEX MOLEX INCORPORATED																
		DRAFT WHERE APPLICABLE MUST REMAIN WITHIN DIMENSIONS	SIZE C	MATERIAL NO. SD-1991-12* DOCUMENT NO.	SHEET NO. 2 OF 2														

THIS DRAWING CONTAINS INFORMATION THAT IS PROPRIETARY TO MOLEX INCORPORATED AND SHOULD NOT BE USED WITHOUT WRITTEN PERMISSION

12 11 10 9 8 7 6 5 4 3 2 1